



Industrial LoRaWAN[®] Gateway

UG56

Quick Guide



Safety Precautions

Milesight will not shoulder responsibility for any loss or damage resulting from not following the instructions of this operating guide.

- The device must not be modeled in any way.
- Do not place the device close to objects with naked flames.
- Do not place the device where the temperature is below/above the operating range.
- Do not power on the device or connect it to another electrical device when installing.
- Check lightning and water protection when used outdoors.
- Do not connect or power the equipment using cables that have been damaged.

Related Documents

This Quick Start Guide only explains the installation of Milesight UG56 LoRaWAN® Gateway. For more functionality and advanced settings, please refer to the relevant documents as below.

Document	Description
UG56 Datasheet	Datasheet for UG56 LoRaWAN® Gateway.
UG56 User Guide	Users can refer to the guide for instruction on how to log in the web GUI, and how to configure all the settings.

The related documents are available on Milesight website: <https://www.milesight-iot.com>

Declaration of Conformity

UG56 is in conformity with the essential requirements and other relevant provisions of the CE, FCC, and RoHS.

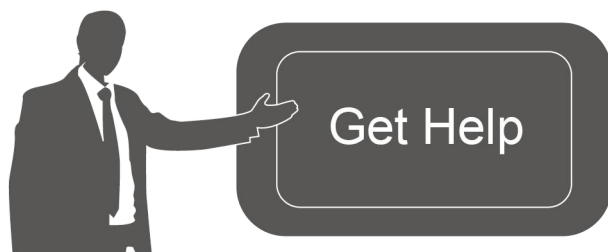

For assistance, please contact
Milesight technical support:
Email: iot.support@milesight.com
Support Portal: support.milesight-iot.com
Tel: 86-592-5085280
Fax: 86-592-5023065

Revision History

Date	Doc Version	Description
Aug.8, 2022	V1.0	Initial version
Apr. 3, 2023	V1.1	Add external cellular antenna option and installation

Contents

1. Packing List	4
2. Hardware Introduction	4
2.1 Overview	4
2.3 LED Indicators	5
2.4 Reset Button	5
3. Hardware Installation	6
3.1 SIM & Micro SD Installation	6
3.2 Antenna Installation	6
3.3 Power Supply	7
3.4 Gateway Installation	7
4. Web GUI Access	9
4.1 Wireless Access	9
4.2 Wired Access	10
5. Network Connection	13
5.1 Configure the Ethernet Connection	13
5.2 Configure the Wi-Fi Connection	13
5.3 Configure the Cellular Connection	14
6. Packet Forwarder Configuration	16
7. Network Server Configuration	18
7.1 Connect UG56 to Milesight IoT Cloud	18
7.2 Connect UG56 to MQTT/HTTP Server	20

1. Packing List

Before you begin to install the UG56 LoRaWAN® Gateway, please check the package contents to verify that you have received the items below.

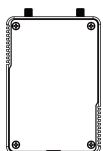

1 × UG56 Device



1 × LoRaWAN®
Magnetic Antenna

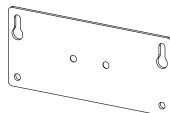

1 × Wall Mounting
Bracket



2 × M3 Bracket Fixing
Screws

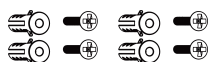

4 x Wall Mounting
Kits



1 x Quick Start Guide



1 × Warranty Card

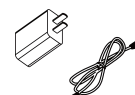

1 × Type-C Cable & Power
Adapter (Optional)



1 × Cellular Magnetic
Antenna
(Cellular Version Only)



If any of the above items is missing or damaged, please contact your sales representative.

2. Hardware Introduction

2.1 Overview

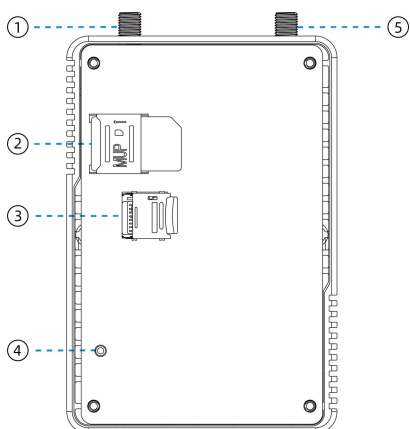

- ① LoRaWAN® Antenna Connector
- ② SIM Slot
- ③ Micro SD Slot
- ④ Reset Button
- ⑤ Cellular Antenna Connector
(Cellular Version Only)

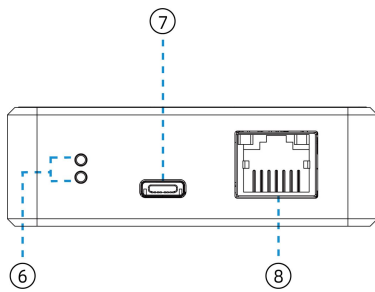

- ⑥ LED Indicators
- ⑦ Type-C Power & Console Port
- ⑧ Ethernet Port (PoE)

2.2 Dimensions (mm)

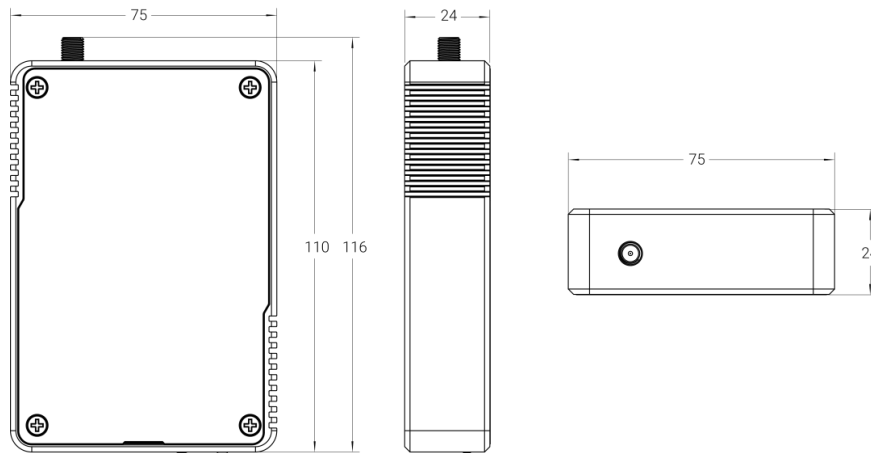

2.3 LED Indicators

LED	Indication	Status	Description
SYS	System Status	Off	The system is starting up
		Red Light	The system goes wrong
		Green Light	The system is running properly
LoRa	LoRa Status	Off	Packet Forwarder mode is running off
		On	Packet Forwarder mode is running well
Ethernet Port	Link Indicator (Yellow)	Off	Disconnected or connect failure
		On	Connected
		Blinking	Transmitting data
	Rate Indicator (Green)	Off	Other modes
On		100 Mbps mode	

2.4 Reset Button

Function	Description	
	SYS LED	Action
Reset	Static Green	Press and hold the reset button for more than 5 seconds.
	Static Green → Rapidly Blinking	Release the button and wait.
	Off → Static Green	The gateway resets to factory default.

3. Hardware Installation

3.1 SIM & Micro SD Installation

Remove the front panel of the device, insert the SIM card or micro SD card into the corresponding slot.

Note: UG56 does not support hot plugging (also called hot swapping). please turn off the power before you insert or take off cards.

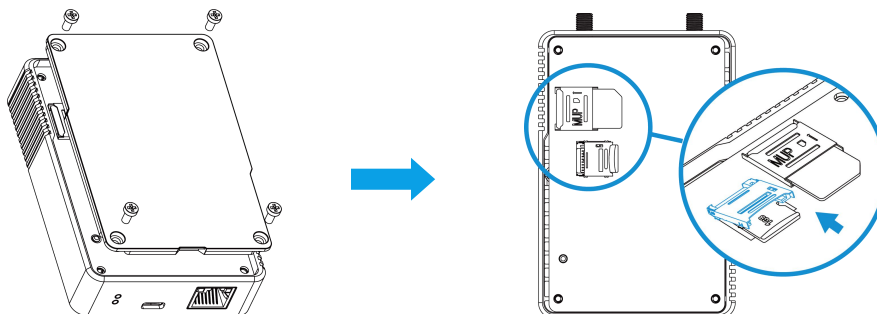

3.2 Antenna Installation

Rotate antennas into the antenna connectors. The antennas should be installed vertically and kept away from barriers.

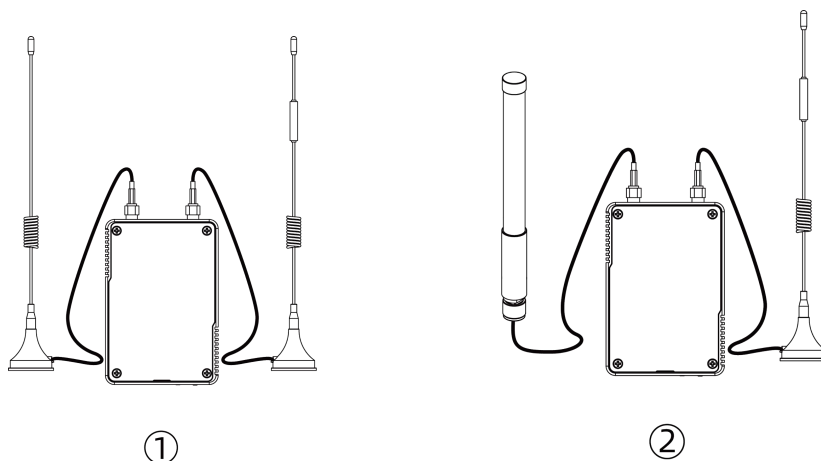

If you need to fix the LoRaWAN® fiber-glass antenna to a pole, please pass the LoRaWAN® antenna through the antenna clamp and fix it with 4 screws, then wrap the U-bolt around a pole and fix the clamp with nuts and other accessories.

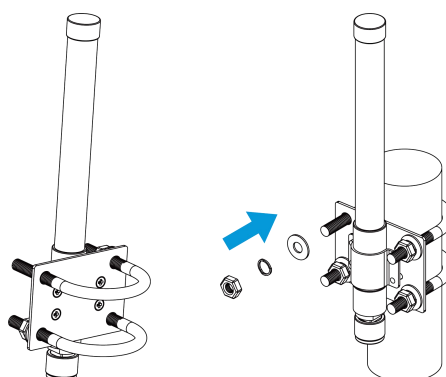

3.3 Power Supply

UG56 can be powered by 802.3af standard PoE or Type-C port (5 VDC). If both are connected, the device will be powered by the former method (PoE).

- **Power by a PoE Switch**

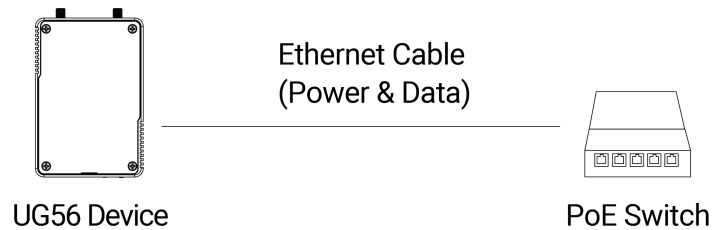

- **Power by a PoE injector**

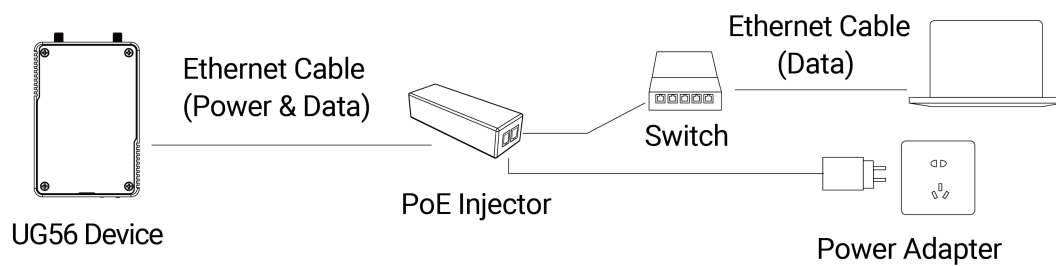

- **Power by a Type-C Port**

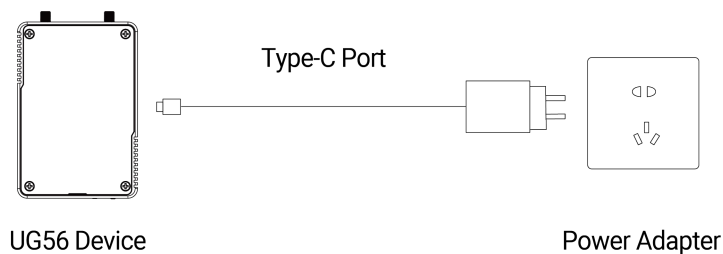

Note: When connecting, Ethernet cable of UG56 device side should be installed first, otherwise, PoE devices or gateway may be damaged.

3.4 Gateway Installation

Before you get started, make sure all fittings are installed and the power supply is disconnected.

A. Fix the wall mounting bracket to the device with 2 x M3 bracket fixing screws.

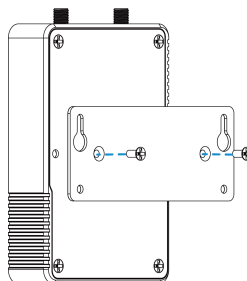

- B. Drill 4 holes on the wall according to the wall mounting bracket, then fix the wall plugs into the wall.
- C. Fix the device to the wall plugs with M3 wall mounting screws. When installation, it's suggested to fix the upper two screws first.

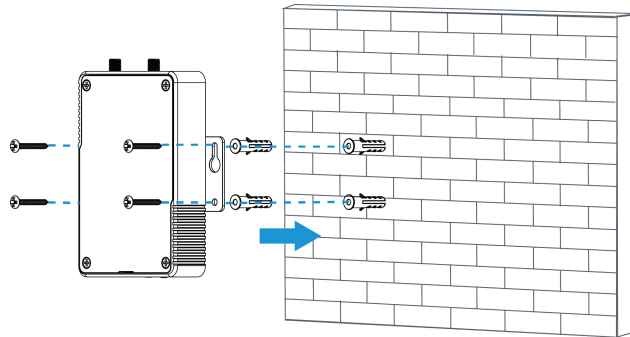

4. Web GUI Access

UG56 provides web-based configuration interface for management. If this is the first time you configure the gateway, please use the default settings below:

ETH IP Address: **192.168.23.150**

Wi-Fi IP Address: **192.168.1.1**

Wi-Fi SSID: **Gateway_*******

Username: **admin**

Password: **password**

Browser: **Chrome(recommended)**

4.1 Wireless Access

A. Enable wireless network connection on your computer and search for access point “**Gateway_*******” to connect it.

B. Open a web browser on your PC (Chrome is recommended) and type in the IP address **192.168.1.1** to access the web GUI, enter the username and password, click “Login”.

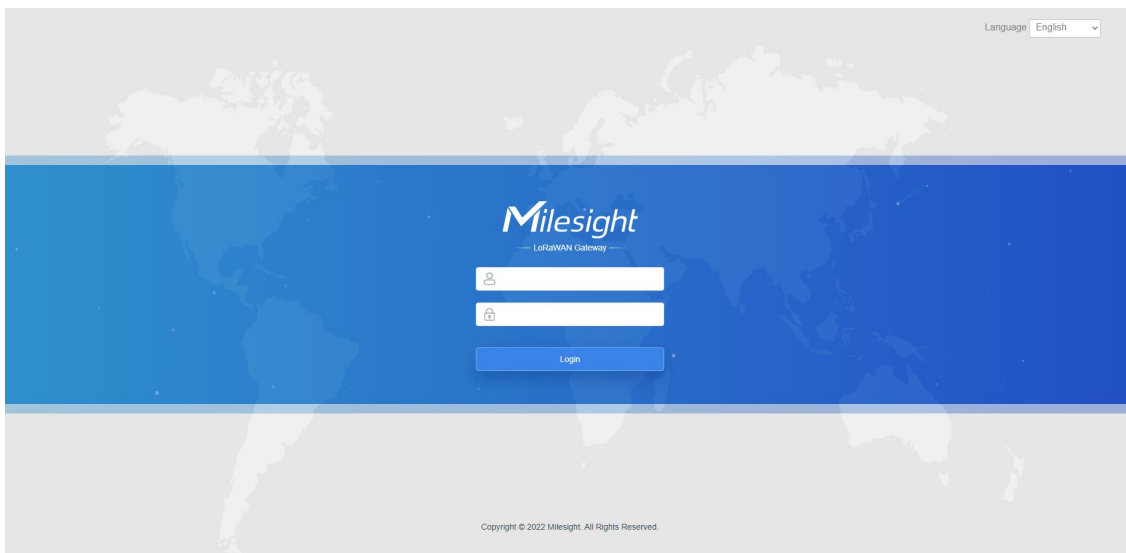

If you enter the username or password incorrectly more than 5 times, the login page will be locked for 10 minutes.

D. After logging the web GUI, follow the guide to complete the basic configurations. It's suggested that you change the password for the sake of security.

Change Your Default Password

For your device security, please change the default password in time.

Old Password

New Password

Confirm New Password

E. You can view system information and perform configuration of the gateway.

admin
↻

For your device security, please change the default password

Status	Overview	Help
Packet Forwarder	Cellular	
Network Server	Network	
Network	WLAN	
System	VPN	
Maintenance	Routing	
APP	Host List	
	Help	
	System Information	
	Model	UG56-L00E-915M
	Region	US915
	Serial Number	6041C2232749
	Firmware Version	56.0.0.1-a2
	Hardware Version	V1.0
	Local Time	2022-08-10 16:31:28 Wednesday
	Uptime	03:10:23
	CPU Load	6%
	RAM (Available/Capacity)	194MB/512MB (37.89%)
	eMMC (Available/Capacity)	6.2GB/7.0GB (88.46%)
	Manual Refresh	Refresh

Model
Show the model name of gateway.

Region
Show the Region of gateway.

Serial Number
Show the serial number of gateway.

Firmware Version
Show the current firmware version of gateway.

Hardware Version
Show the current hardware version of gateway.

Local Time
Show the current local time of system.

Uptime
Show the information on how long the gateway has been running.

4.2 Wired Access

Connect PC to UG56 ETH port directly or through PoE injector to access the web GUI of gateway. The following steps are based on Windows 10 system for your reference.

A. Go to "Control Panel" → "Network and Internet" → "Network and Sharing Center", then click "Ethernet" (It may have different names).

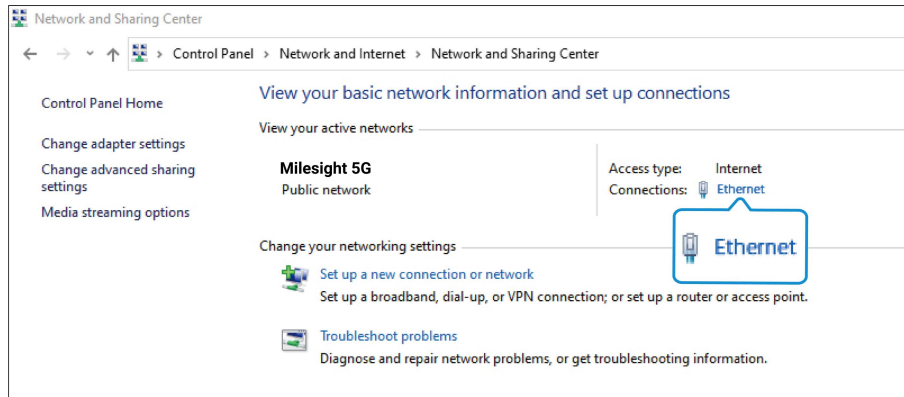

B. Go to “Properties” → “Internet Protocol Version 4 (TCP/IPv4)” and select “Use the following IP address”, then assign a static IP manually within the same subnet of UG56.

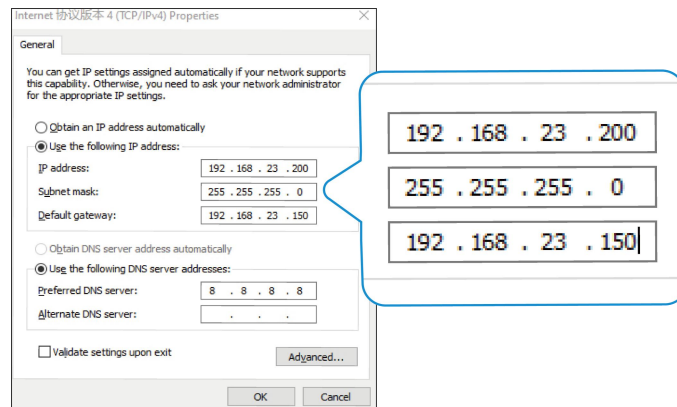

C. Open a Web browser on your PC (Chrome is recommended) and type in the IP address 192.168.23.150 to access the web GUI.

D. Enter the username and password, click “Login”.

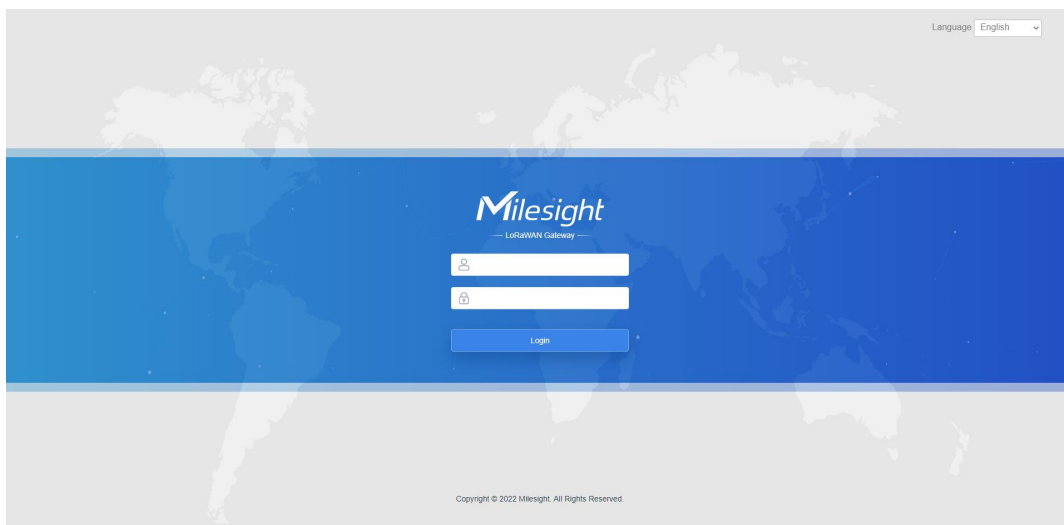

If you enter the username or password incorrectly more than 5 times, the login page will be locked for 10 minutes.

E. After logging the web GUI, follow the guide to complete the basic configurations. It's suggested that you change the password for the sake of security.

Change Your Default Password

For your device security, please change the default password in time.

Old Password

New Password

Confirm New Password

F. You can view system information and perform configuration of the gateway.

admin🔗

For your device security, please change the default password.

Status	Overview	Cellular	Network	WLAN	VPN	Routing	Host List	Help																				
Packet Forwarder	System Information <table style="width: 100%; border-collapse: collapse;"><tr><td style="width: 30%;">Model</td><td>UG56-L00E-915M</td></tr><tr><td>Region</td><td>US915</td></tr><tr><td>Serial Number</td><td>6041C2232749</td></tr><tr><td>Firmware Version</td><td>56.0.0.1-a2</td></tr><tr><td>Hardware Version</td><td>V1.0</td></tr><tr><td>Local Time</td><td>2022-08-10 16:31:28 Wednesday</td></tr><tr><td>Uptime</td><td>03:10:23</td></tr><tr><td>CPU Load</td><td>6%</td></tr><tr><td>RAM (Available/Capacity)</td><td>194MB/512MB (37.89%)</td></tr><tr><td>eMMC (Available/Capacity)</td><td>6.2GB/7.0GB (88.46%)</td></tr></table> <div style="text-align: right; margin-top: 10px;"><input type="button" value="Manual Refresh"/> <input type="button" value="Refresh"/></div>							Model	UG56-L00E-915M	Region	US915	Serial Number	6041C2232749	Firmware Version	56.0.0.1-a2	Hardware Version	V1.0	Local Time	2022-08-10 16:31:28 Wednesday	Uptime	03:10:23	CPU Load	6%	RAM (Available/Capacity)	194MB/512MB (37.89%)	eMMC (Available/Capacity)	6.2GB/7.0GB (88.46%)	Model <small>Show the model name of gateway.</small>
Model								UG56-L00E-915M																				
Region								US915																				
Serial Number								6041C2232749																				
Firmware Version								56.0.0.1-a2																				
Hardware Version								V1.0																				
Local Time								2022-08-10 16:31:28 Wednesday																				
Uptime								03:10:23																				
CPU Load	6%																											
RAM (Available/Capacity)	194MB/512MB (37.89%)																											
eMMC (Available/Capacity)	6.2GB/7.0GB (88.46%)																											
Network Server	Region <small>Show the Region of gateway.</small>																											
Network ▶	Serial Number <small>Show the serial number of gateway.</small>																											
System ▶	Firmware Version <small>Show the current firmware version of gateway.</small>																											
Maintenance ▶	Hardware Version <small>Show the current hardware version of gateway.</small>																											
APP ▶	Local Time <small>Show the current local time of system.</small>																											
	Uptime <small>Show the information on how long the gateway has been running.</small>																											

5. Network Connection

This section explains how to connect the gateway to network via WAN connection, Wi-Fi or cellular.

5.1 Configure the Ethernet Connection

- Go to “Network” → “Interface” → “Port” page to select the connection type and configure Ethernet port information.
- Click “Save & Apply” for changes to take effect.

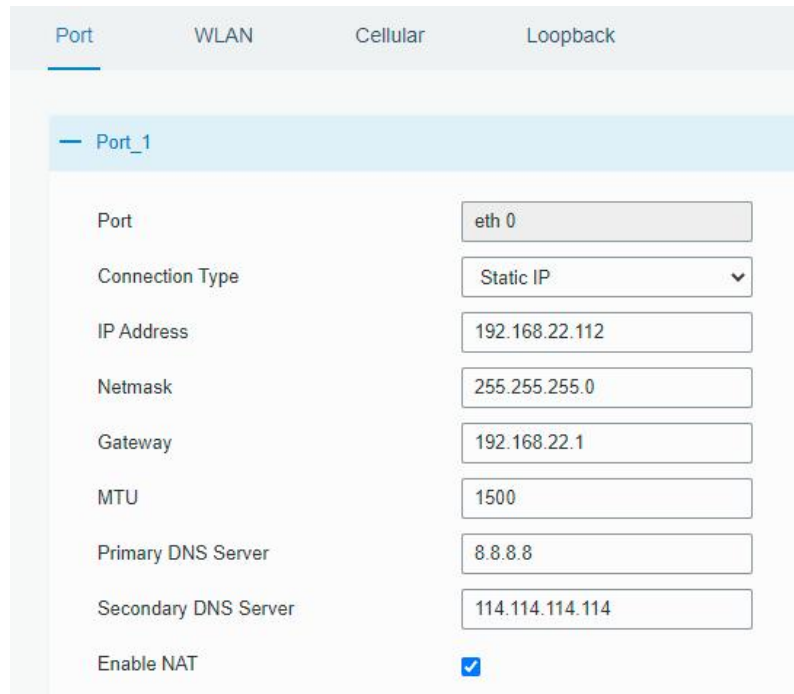

Port	WLAN	Cellular	Loopback
Port_1			
Port	eth 0		
Connection Type	Static IP		
IP Address	192.168.22.112		
Netmask	255.255.255.0		
Gateway	192.168.22.1		
MTU	1500		
Primary DNS Server	8.8.8.8		
Secondary DNS Server	114.114.114.114		
Enable NAT	<input checked="" type="checkbox"/>		

- Connect Ethernet port of gateway to the devices like router or modem.
- Log in the web GUI via the newly assigned IP address and go to “Status” → “Network” to check Ethernet port status.



Overview	Packet Forward	Cellular	Network	WLAN	VPN	Host List	
WAN							
Port	Status	Type	IP Address	Netmask	Gateway	DNS	Duration
eth 0	up	Static	192.168.22.112	255.255.255.0	192.168.22.1	8.8.8.8	1days,02h 34m 22s

5.2 Configure the Wi-Fi Connection

- Go to “Network” → “Interface” → “WLAN” and select “Client” mode.
- Click “Scan” to search for Wi-Fi access points. Select the available one and click “Join Network”.

Port	WLAN	Cellular	Loopback				
< GoBack							
SSID	Channel	Signal	Cipher	BSSID	Security	Frequency	
AAA	Auto	-61dBm	AES	24:e1:24:f0:c4:13	WPA-PSK/WPA2-PSK	2412MHz	Join Network

C. Type the key of Wi-Fi.

Port	WLAN	Cellular	Loopback
WLAN			
Enable	<input checked="" type="checkbox"/>		
Work Mode	Client		Scan
SSID	AAA		
BSSID	24:e1:24:f0:c4:13		
Encryption Mode	WPA-PSK/WPA2-PSK		
Cipher	AES		
Key		
IP Setting			
Protocol	DHCP Client		

D. Go to "Status" → "WLAN" to check Wi-Fi status. If it shows "Connected", it means gateway connects to Wi-Fi successfully.

Overview	Packet Forward	Cellular	Network	WLAN
WLAN Status				
Wireless Status	Enabled			
MAC Address	24:e1:24:f0:de:14			
Interface Type	Client			
SSID	AAA			
Channel	Auto			
Encryption Type	WPA-PSK/WPA2-PSK			
Cipher	AES			
Status	Connected			
IP Address	192.168.1.145			
Netmask	255.255.255.0			
Connection Duration	0 days, 02:44:45			

5.3 Configure the Cellular Connection

A. Go to "Network" → "Interface" → "Cellular" → "Cellular Setting" page to enable cellular settings.

- B. Choose relevant network type and fill in SIM card information like APN or PIN code.
C. Click “Save” and “Apply” for changes to take effect.

Port	WLAN	Cellular	Loopback
Cellular Setting			
Enable		<input checked="" type="checkbox"/>	
Network Type		Auto	
APN			
Username			
Password			
Access Number			
PIN Code			
Authentication Type		Auto	
Roaming		<input checked="" type="checkbox"/>	
SMS Center			
Connection Setting		<input type="checkbox"/>	
Enable NAT		<input checked="" type="checkbox"/>	

- D. Go to “Status” → “Cellular” page to view the status of the cellular connection. If it shows “Connected”, it means the SIM has dialed up successfully.

Overview	Packet Forward	Cellular	Network	WLAN
Modem				
Status		Ready		
Model		EC25		
Version		EC25ECGAR06A07M1G		
Signal Level		23asu (-67dBm)		
Register Status		Registered (Home network)		
IMEI		860425047368939		
IMSI		460019425301842		
ICCID		89860117838009934120		
ISP		CHN-UNICOM		
Network Type		LTE		
PLMN ID				
LAC		5922		
Cell ID		340db83		
Network				
Status		Connected		
IP Address		10.132.132.59		
Netmask		255.255.255.240		
Gateway		10.132.132.60		

6. Packet Forwarder Configuration



UG has installed multiple packet forwarders including Semtech, Chirpstack-Generic MQTT broker, etc. This section explains how to connect the gateway to network servers.

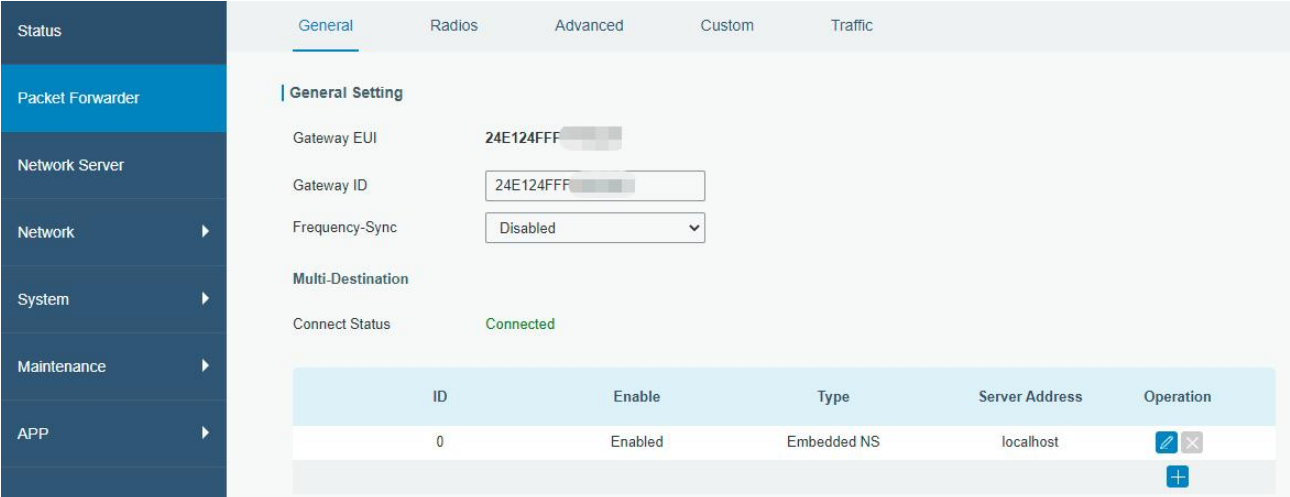

Make sure the gateway connects to the network as shown in [Section 5](#).

A. Go to “Packet Forwarder” → “General” page and click  to add a network server.



ID	Enable	Type	Server Address	Operation
0	Enabled	Embedded NS	localhost	 

B. Fill in the server information and enable this server.

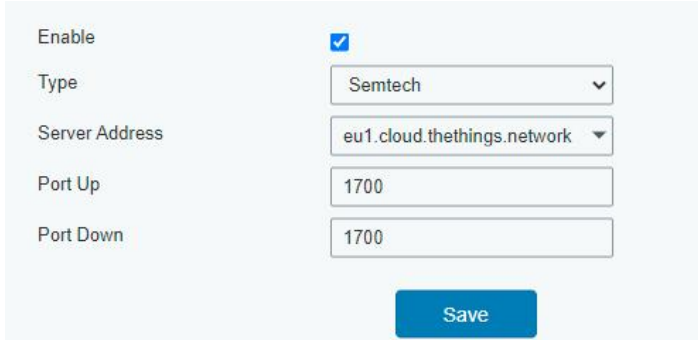

Enable

Type

Server Address

Port Up

Port Down

C. Go to “Packet Forwarder” → “Radio” page, center frequency and channels. The channels of the gateway and network server need to be the same.

Region US915

Name	Center Frequency/MHz
Radio 0	904.3
Radio 1	905.0

Multi Channels Setting

Enable	Index	Radio	Frequency/MHz
<input checked="" type="checkbox"/>	0	Radio 0	903.9
<input checked="" type="checkbox"/>	1	Radio 0	904.1
<input checked="" type="checkbox"/>	2	Radio 0	904.3
<input checked="" type="checkbox"/>	3	Radio 0	904.5
<input checked="" type="checkbox"/>	4	Radio 1	904.7
<input checked="" type="checkbox"/>	5	Radio 1	904.9
<input checked="" type="checkbox"/>	6	Radio 1	905.1
<input checked="" type="checkbox"/>	7	Radio 1	905.3

D. Add the gateway on network server page. For more details about the network server connection please refer to [Milesight IoT Support portal](#).

E. Go to "Traffic" page to view the data communication of UG56.

General Radios Advanced Custom **Traffic**

Traffic Setting

Stop Clear

Rfch	Direction	Time	Ticks	Frequency	Datarate	Coderate	RSSI	SNR
1	up	11:52:38	317882157 1	865.985	SF7BW125	4/5	-91	5.0
1	up	11:52:22	316226269 2	866.585	SF7BW125	4/7	-108	-11.8
0	down	-	311888813 1	865.0625	SF7BW125	4/5	-	-
0	up	11:51:37	311788813 1	865.0625	SF7BW125	4/5	-95	-0.8

7. Network Server Configuration

UG56 can work as network server and transmit data to Milesight IoT Cloud or another platform via MQTT/HTTP/HTTPS.



Make sure the gateway connects to the network as shown in [Section 5](#).

7.1 Connect UG56 to Milesight IoT Cloud

A. Go to “Packet Forwarder” → “General” page to enable the embedded network server.

The screenshot shows the 'General Setting' page for Packet Forwarder. The 'Gateway EUI' is 24E124FFF, 'Gateway ID' is 24E124FF, and 'Frequency-Sync' is Disabled. The 'Multi-Destination' section shows 'Connect Status' as Connected. Below this is a table of network servers:

ID	Enable	Type	Server Address	Operation
0	Enabled	Embedded NS	localhost	

B. Go to “Packet Forwarder” → “Radio” page to select the antenna type, center frequency and channels. The channels of the gateway and nodes need to be the same.

The screenshot shows the 'Radio' configuration page. The 'Region' is set to US915. There are two radio entries:

Name	Center Frequency/MHz
Radio 0	904.3
Radio 1	905.0

Below this is the 'Multi Channels Setting' table:

Enable	Index	Radio	Frequency/MHz
<input checked="" type="checkbox"/>	0	Radio 0	903.9
<input checked="" type="checkbox"/>	1	Radio 0	904.1
<input checked="" type="checkbox"/>	2	Radio 0	904.3
<input checked="" type="checkbox"/>	3	Radio 0	904.5
<input checked="" type="checkbox"/>	4	Radio 1	904.7
<input checked="" type="checkbox"/>	5	Radio 1	904.9
<input checked="" type="checkbox"/>	6	Radio 1	905.1
<input checked="" type="checkbox"/>	7	Radio 1	905.3

C. Go to “Network Server” → “General” page to enable the network server and “Milesight IoT Cloud” mode.

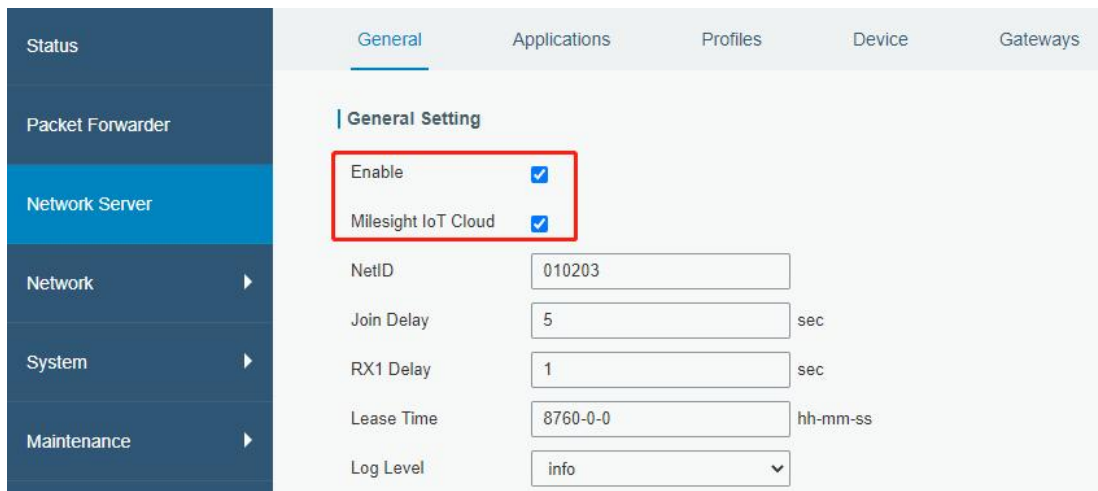

D. Log in the Milesight IoT Cloud. Then go to “My Devices” page and click “+New Devices” to add gateway to Milesight IoT Cloud via SN. Gateway will be added under “Gateways” menu.

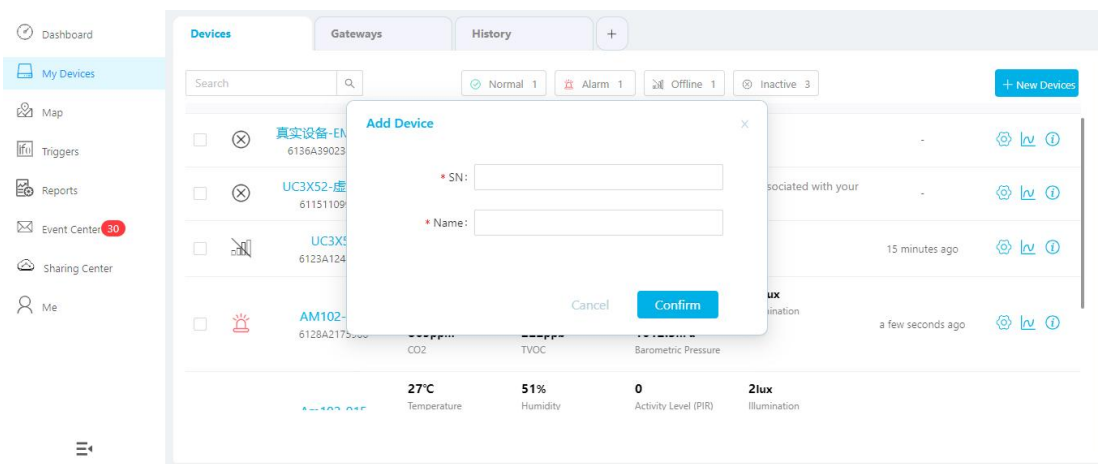

E. The gateway is online on Milesight IoT Cloud.

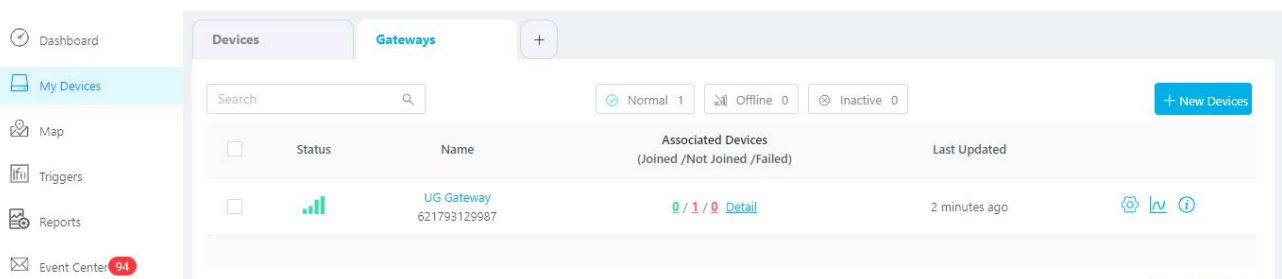

7.2 Connect UG56 to MQTT/HTTP Server

A. Go to “Packet Forwarder” → “General” page to enable the embedded network server.

The screenshot shows the 'General Setting' page for the Packet Forwarder. The 'Connect Status' is 'Connected'. Below the settings, there is a table with the following data:

ID	Enable	Type	Server Address	Operation
0	Enabled	Embedded NS	localhost	

B. Go to “Packet Forwarder” → “Radio” page to select the antenna type, center frequency and channels. The channels of the gateway and nodes need to be the same.

The screenshot shows the 'Radio' page with the 'Region' set to 'US915'. The following table shows the defined radio channels:

Name	Center Frequency/MHz
Radio 0	904.3
Radio 1	905.0

Below this, the 'Multi Channels Setting' table is shown:

Enable	Index	Radio	Frequency/MHz
<input checked="" type="checkbox"/>	0	Radio 0	903.9
<input checked="" type="checkbox"/>	1	Radio 0	904.1
<input checked="" type="checkbox"/>	2	Radio 0	904.3
<input checked="" type="checkbox"/>	3	Radio 0	904.5
<input checked="" type="checkbox"/>	4	Radio 1	904.7
<input checked="" type="checkbox"/>	5	Radio 1	904.9
<input checked="" type="checkbox"/>	6	Radio 1	905.1
<input checked="" type="checkbox"/>	7	Radio 1	905.3

C. Go to “Network Server” → “General” page to enable the network server mode.

General	Applications	Profiles	Device	Gateways
General Setting				
Enable	<input checked="" type="checkbox"/>			
Milesight IoT Cloud	<input type="checkbox"/>			
NetID	<input type="text" value="010203"/>			
Join Delay	<input type="text" value="5"/> sec			
RX1 Delay	<input type="text" value="1"/> sec			
Lease Time	<input type="text" value="876000-0-0"/> hh-mm-ss			
Log Level	<input type="text" value="info"/>			

D. Go to “Network Server”→“Application” to add a new application.

General	Applications	Profiles	Device
Applications			
Name	<input type="text" value="cloud"/>		
Description	<input type="text" value="cloud"/>		
Payload Codec	<input type="text" value="None"/>		

After saving the application, you can select HTTP, HTTPS or MQTT protocol and fill in corresponding server information to send data to another server.

Data Transmission	
Type	<input type="text" value="MQTT"/>
Status	<input type="text" value="MQTT"/>
General	
Broker Address	<input type="text"/>
Broker Port	<input type="text"/>
Client ID	<input type="text"/>
Connection Timeout/s	<input type="text" value="30"/>
Keep Alive Interval/s	<input type="text" value="60"/>

E. Go to “Profiles” page to add a new profile for the device.

General Applications **Profiles** Device

Device Profiles

Name

Max TXPower

Join Type ▼

Class Type Class A Class B Class C

Advanced

F. Go to “Device” page and click “Add” to add LoRaWAN® node devices.

General Applications Profiles **Device** Gateways Packets

Device

Device Name	Device EUI	Device-Profile	Application	Last Seen	Activated	Operation
No matching records found						

Device Name

Description

Device EUI

Device-Profile ▼

Application ▼

Frame-counter Validation

Application Key

Device Address

Network Session Key

Application Session Key

Uplink Frame-counter

Downlink Frame-counter

You can also click “Bulk Import” if you want to add many nodes all at once.

Import File

Click “Template Download” to download template file and add device information to this file. Application

and device profile should be the same as you created on web page.

	A	B	C	D	E	F	G	H	I
1	name	description	deveui	application	deviceprofile	appkey	devaddr	appskey	nwkskey
2	24e1242191323266		24e1242191323266	cloud	ClassC-OTAA	112233445566778899aa112233445566			
3									
4									
5									

Import this file to add bulks of devices.

F. Go to “Packets” page to check the packets from LoRaWAN® node devices. The type starts from “Up” means uplinks and “Dn” means downlinks.

Network Server

Clear Search 🔍

Device EUI	Frequency	Datarate	SNR	RSSI	Size	Fcnt	Type	Time	Details
24e124126a146579	868300000	SF7BW125	8.5	-85	4	14	UpUnc	2020-04-28T15:09:25+08:00	!
24e124126a146579	868300000	SF7BW125	10.2	-75	4	13	UpUnc	2020-04-28T15:04:25+08:00	!

Click “Details” to check the properties and payload contents of packets.

Packets Details ✕

Fcnt	14
Port	85
Modulation	LORA
Bandwidth	125
SpreadFactor	7
Bitrate	0
CodeRate	4/5
SNR	8.5
RSSI	-85
Power	-
Payload(b64)	A3cYAA==
Payload(hex)	03771800
MIC	f5acdeb2

[END]